

SW12 MICRO SWITCHES



Parameter

rating	26	26(16A) 125V/250V AC (30A250V/125V AC)
	22	22(8)A 125V/250V AC
	16	16(16)A 125V/250V AC 16(4) 125V/250V AC 16A 125V/250V AC 16A 36V DC
		10
	05	5(2.5)A 125/250V AC 0.1A 125/250V AC 0.1A 36V DC
life span	electrical	50,000 times 10-30 times/minute
	mechanical	1,000,000 times 60-120 times/minute
certificate	UL CUL ENEC CE CB ROHS	
initial contact resistance	50 mΩ Max	
insulation resistance	100MΩ Min	
electric tension	AC 1500V (50 ~ 60Hz)	
temperature	25T125	

Contacting Picture

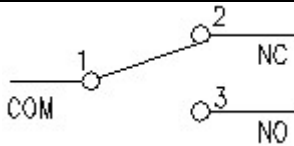
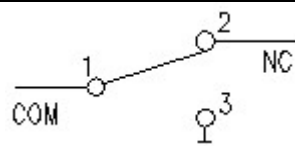
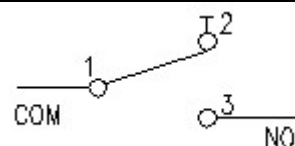
Z SPDT	C SPST	P SPST
		

Size & Characteristic

SW12TB_053C

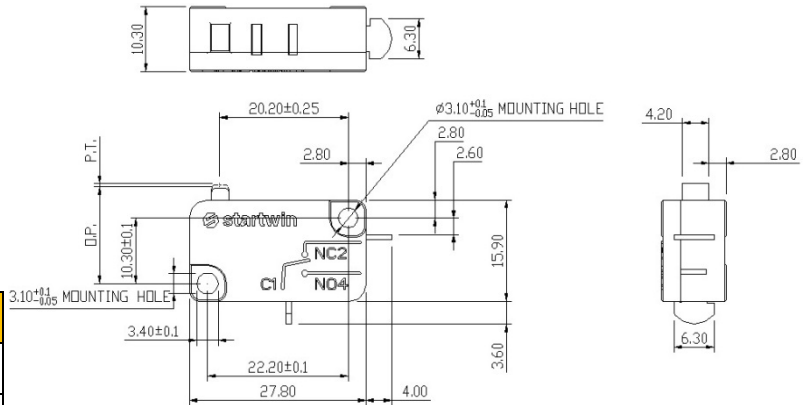

OF	RF	PT	DT	OP
400 gf Max	200 gf Min	1.6 mm Max	0.4 mm Max	14.7±0.5mm
250 gf Max	100 gf Min	1.6 mm Max	0.4 mm Max	14.7±0.5mm
200 gf Max	75 gf Min	1.6 mm Max	0.4 mm Max	14.7±0.5mm
100 gf Max	35 gf Min	1.6 mm Max	0.4 mm Max	14.7±0.5mm

SW12TB_053P

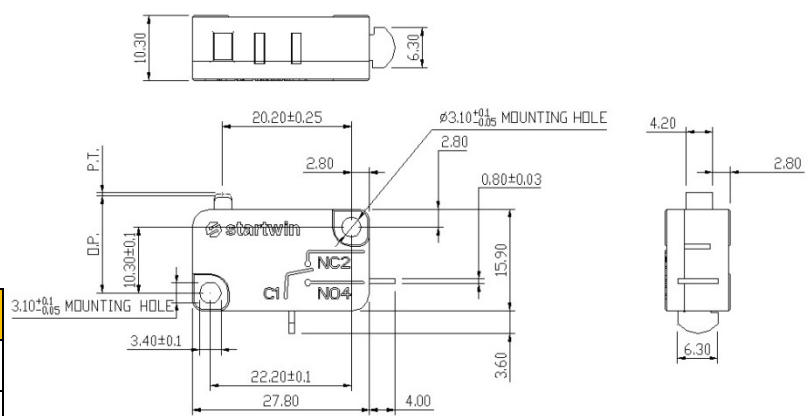

OF	RF	PT	DT	OP
400 gf Max	200 gf Min	1.6 mm Max	0.4 mm Max	14.7±0.5mm
250 gf Max	100 gf Min	1.6 mm Max	0.4 mm Max	14.7±0.5mm
200 gf Max	75 gf Min	1.6 mm Max	0.4 mm Max	14.7±0.5mm
100 gf Max	35 gf Min	1.6 mm Max	0.4 mm Max	14.7±0.5mm

SW12TB_053Z

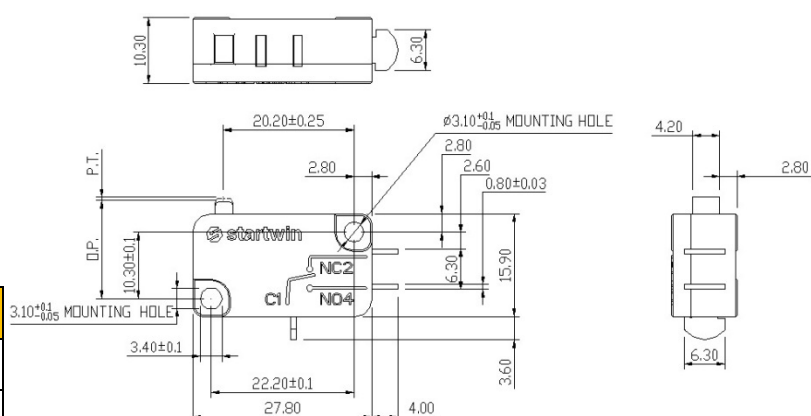

OF	RF	PT	DT	OP
400 gf Max	200 gf Min	1.6 mm Max	0.4 mm Max	14.7±0.5mm
250 gf Max	100 gf Min	1.6 mm Max	0.4 mm Max	14.7±0.5mm
200 gf Max	75 gf Min	1.6 mm Max	0.4 mm Max	14.7±0.5mm
100 gf Max	35 gf Min	1.6 mm Max	0.4 mm Max	14.7±0.5mm

Installation Size

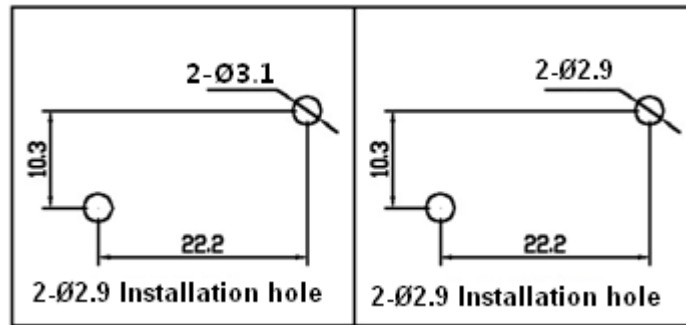

Movement of Switches

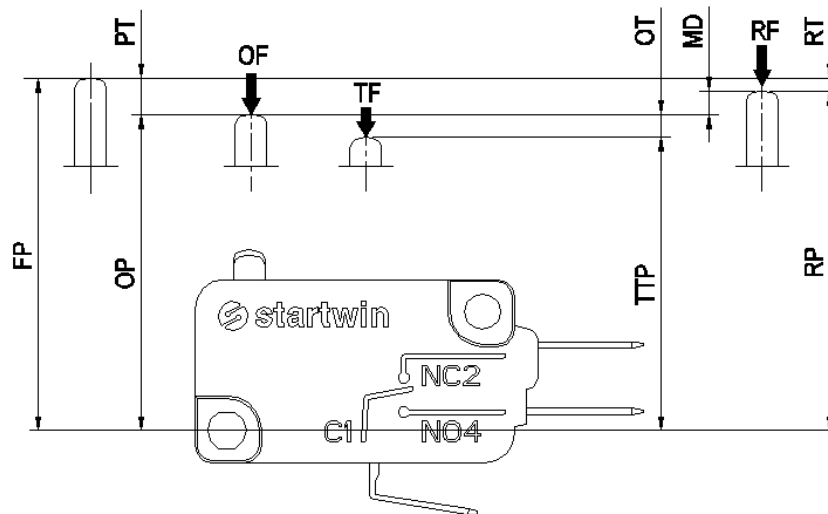

Name	Parameter	Explanation
PT	Pre Travel	Movement from Free Position to Over Position
OT	Over Travel	Movement from Over Position to Total Travel Position
DT	Movement Differential Travel	Movement from Over Position to Release Position
RT	Release Travel	Movement from Release Position to Free Position
OF	Operating Force	Max Operating Force from Free Position to Over Position
RF	Release Force	Minimal Operating Force from Over Position to Release Position
TTP	Total Travel Position	The drive member is located in the stop osition
OP	Over Position	Instant position in forward movement
RP	Release Position	Instant position in reverse movement
FP	Free Position	Position without of lacking forces